

The Fabulous Dipole

Ham Radio's Most Versatile Antenna

What is a Dipole?

- **Gets its name from its two halves**
 - One leg on each side of center
 - Each leg is the same length
- **It's a balanced antenna**
 - The voltages and currents are balanced across each leg
 - Does not need a counterpoise or ground radials
- **At resonance, the total antenna length is one-half design frequency wavelength**
- **One of the simplest and effective antennas**

The Dipole

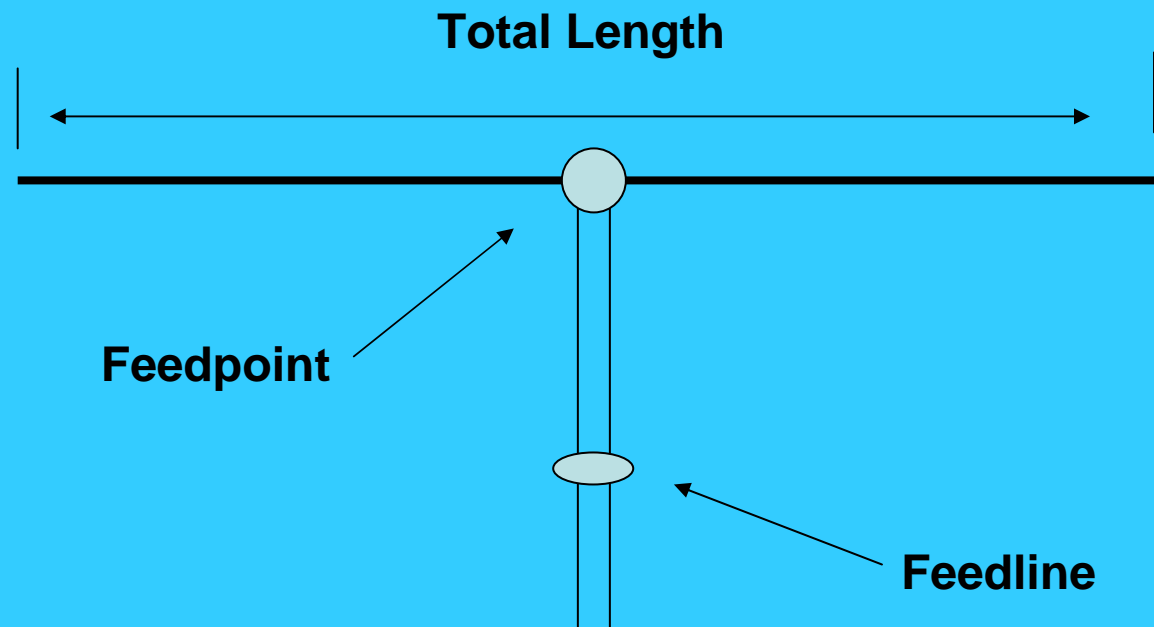

**Antenna total length
468/freq. in mhz**

Approximate Total Length for Half-wave Dipoles

Band	Freq., Mhz	Length
10	28.4	16" 6"
12	24.9	18" 10"
15	21.1	22" 2"
17	18.1	25" 10"
20	14.1	33" 2"
30	10.1	46" 4"
40	7.1	65" 11"
60	5.2	89' 7"
80	3.6	130'
160	1.8	260'

Typical Construction Materials

- **#14 or #12 gauge wire for the legs**
 - Copperweld
 - Stranded
 - Do NOT use typical solid copper wire as it will stretch and go off design frequency
 - For short term use, the legs can be #18 or #16 gauge wire
- **The feedline can be coax or twin-lead**
 - If coax is used, a balun is desirable at feed point

Typical Dipole Characteristics

- **Feed point resistance**
 - In free space, – 72 ohms
 - Above real ground – 30 to 70 ohms
- **Reactance at feed point**
 - Capacitive if too long
 - Inductive if too short
 - Null out by adding the opposite reactance
- **At resonance, only resistance – no reactance**

More Dipole Characteristics

- **Bandwidth – the amount of frequency between the 2:1 SWR points**
 - **Narrow at low frequencies**
(100 khz @ 3.6 mhz - entire band @ 14.2 mhz)
- **Take Off Angles**
 - **The angle of maximum radiation in the horizontal**
 - **Depends upon height (wavelength) above RF ground (not the ground surface)**
 - **The higher above RF ground, the lower the take off angle**
- **Reduced man-made noise reception**

Feed Point Resistance at Various Heights Above RF Ground

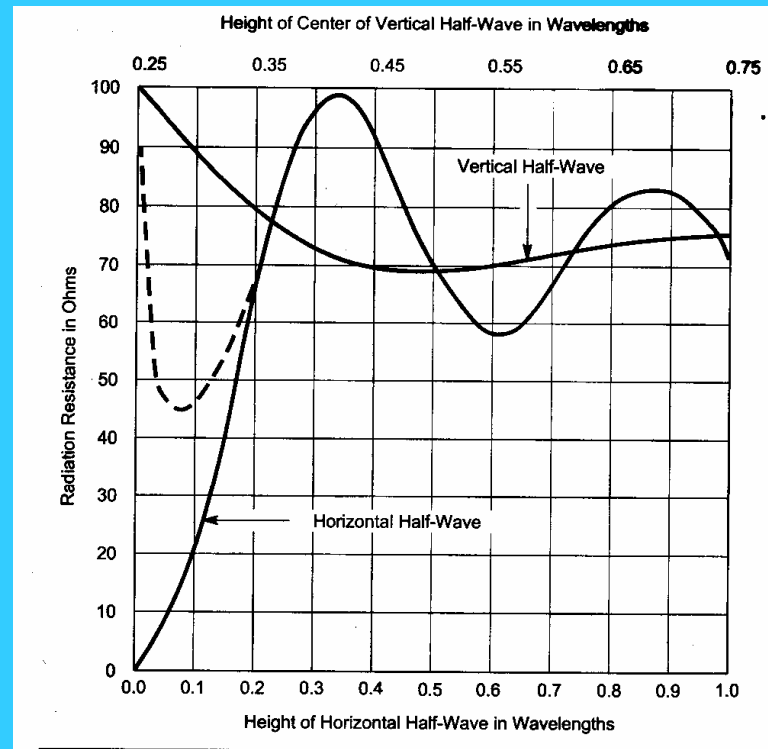
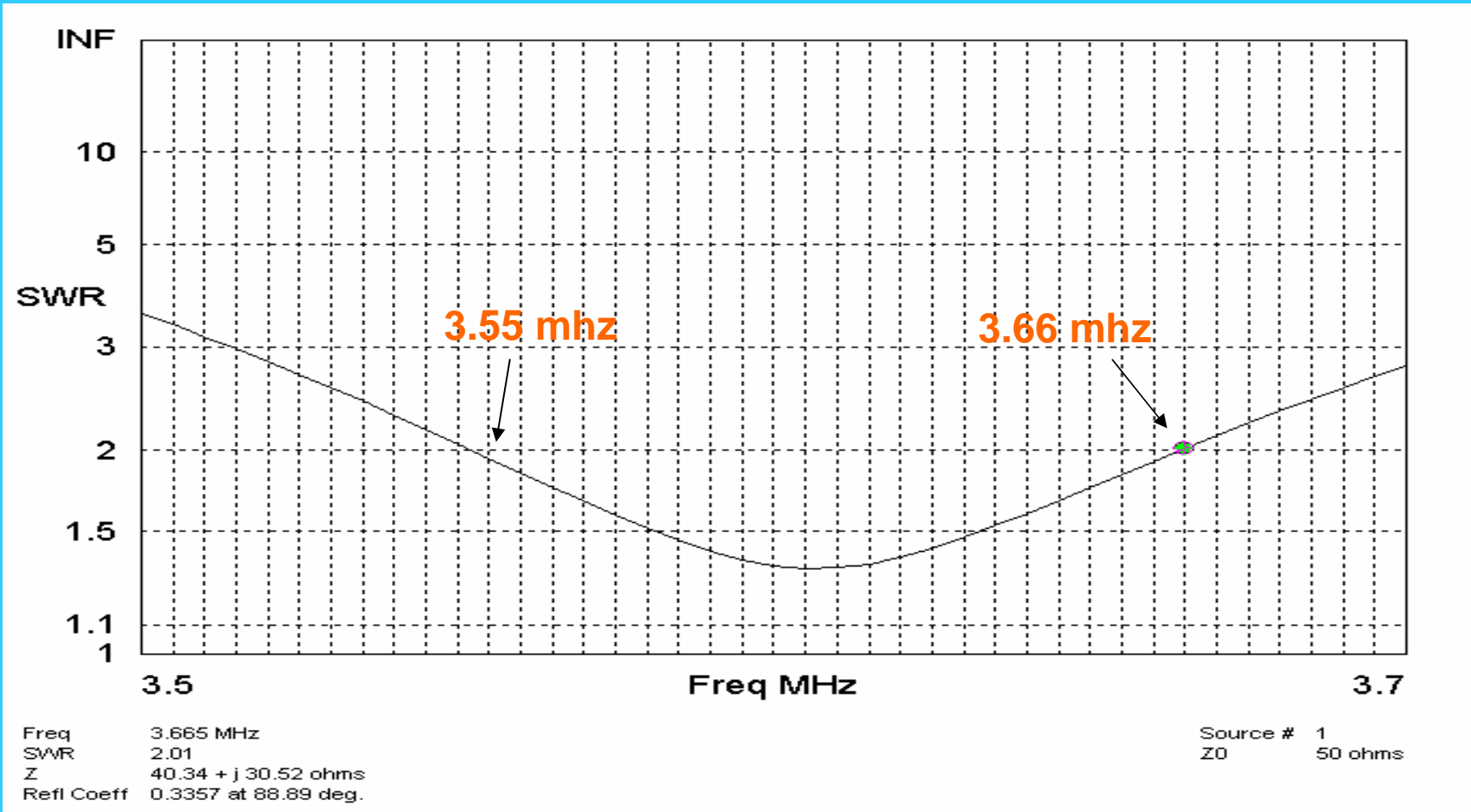

Fig 1—Variation in radiation resistance of vertical and horizontal half-wave antennas at various heights above flat ground. Solid lines are for perfectly conducting ground; the broken line is the radiation resistance of horizontal half-wave antennas at low height over real ground.

SWR – 2:1 Bandwidth

**The frequency between the
2:1 SWR frequency points**

3.6 mhz Dipole @ 30 ft. Eznec 4.0 Plot



14.1 mhz Dipole @ 30 ft. Eznec 4.0 Plot

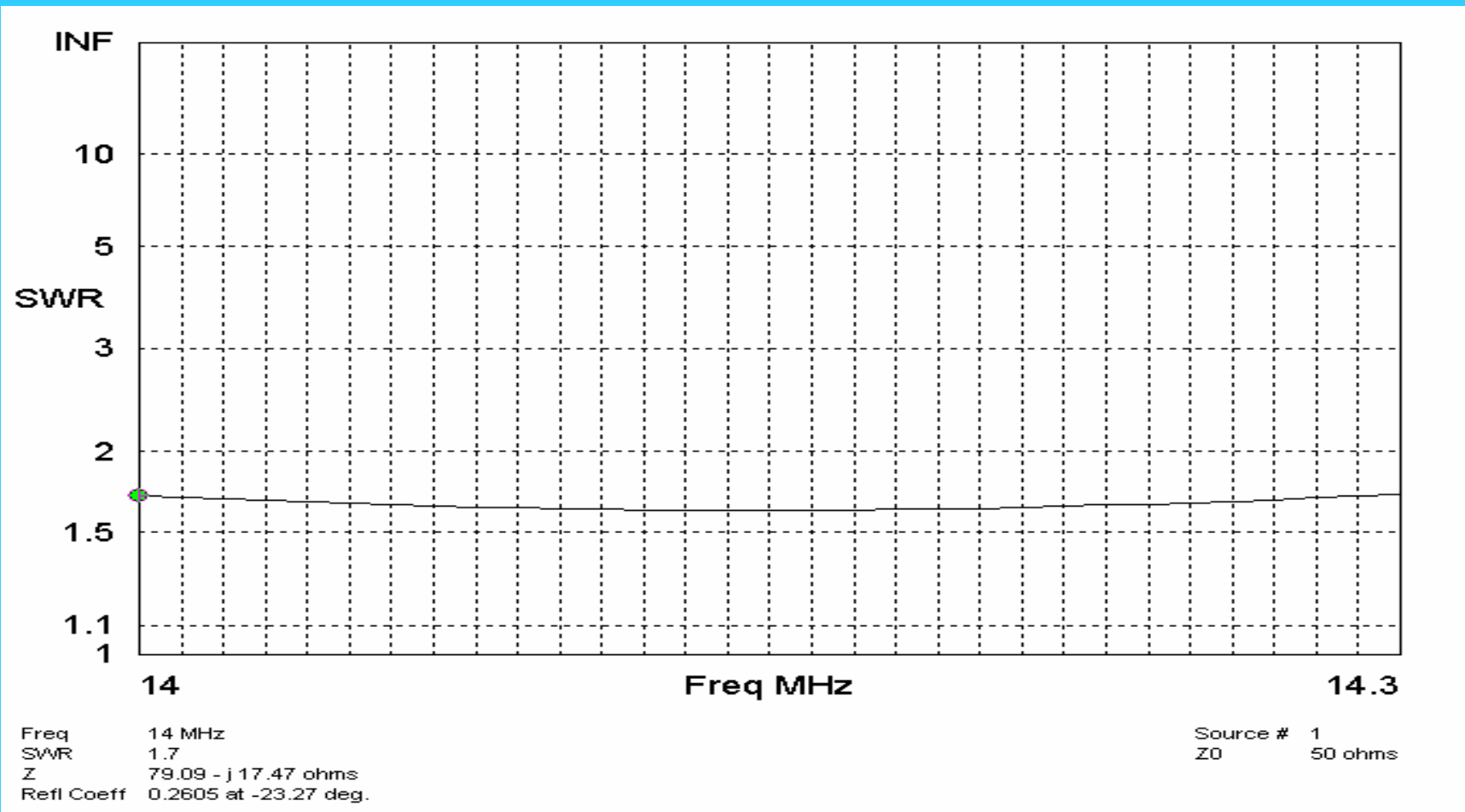

Take Off Angles

- **The angle above antenna horizontal that as the greatest gain.**
- **Also important is the -3 db “beam width”**
 - **The degrees of take off angles between the maximum gain and -3 db gain points**

Take Off Angle @ 3.6 mhz 30 feet above real ground

* Total Field

EZNEC

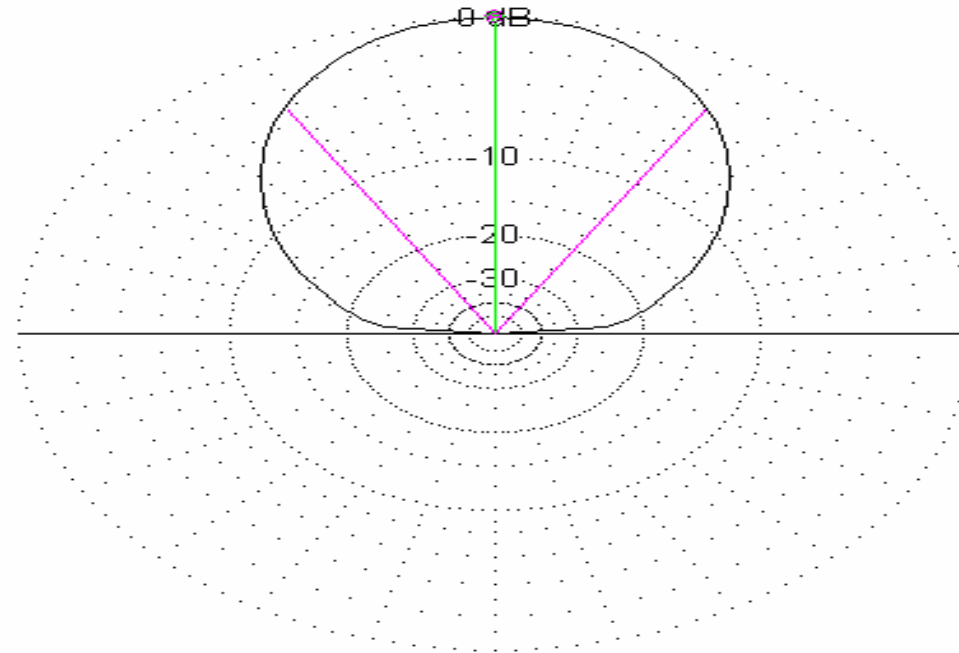

Elevation Plot	
Azimuth Angle	0.0 deg.
Outer Ring	6.98 dBi
3D Max Gain	6.98 dBi
Slice Max Gain	6.98 dBi @ Elev Angle = 90.0 deg.
Beamwidth	63.5 deg.; -3dB @ 58.2, 121.7 deg.
Sidelobe Gain	< -100 dBi
Front/Sidelobe	> 100 dB

3.6 MHz
Cursor Elev 90.0 deg.
Gain 6.98 dBi
0.0 dBmax
0.0 dBmax3D

Note: This is an NVIS pattern.

Take Off Angle @ 14.1 mhz 30 feet above real ground

* **Total Field**

EZNEC

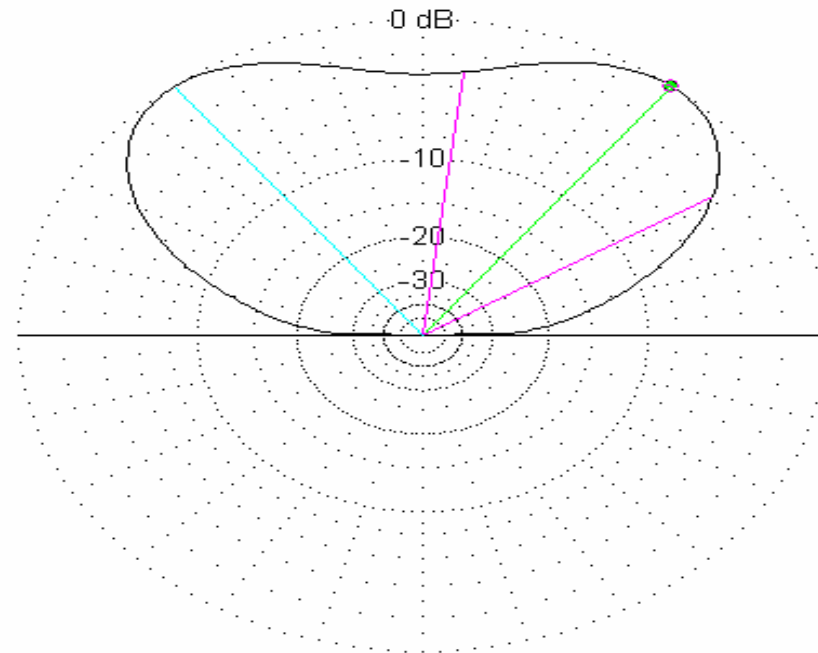

Elevation Plot
Azimuth Angle 0.0 deg.
Outer Ring 1.69 dBi

Slice Max Gain 1.69 dBi @ Elev Angle = 52.0 deg.
Beamwidth 51.7 deg.; -3dB @ 31.4, 83.1 deg.
Sidelobe Gain 1.66 dBi @ Elev Angle = 128.0 deg.
Front/Sidelobe 0.04 dB

14 MHz
Cursor Elev 52.0 deg.
Gain 1.69 dBi
0.0 dBmax

Take Off Angle @ 14.1 mhz 40 feet above real ground

* **Total Field**

EZNEC

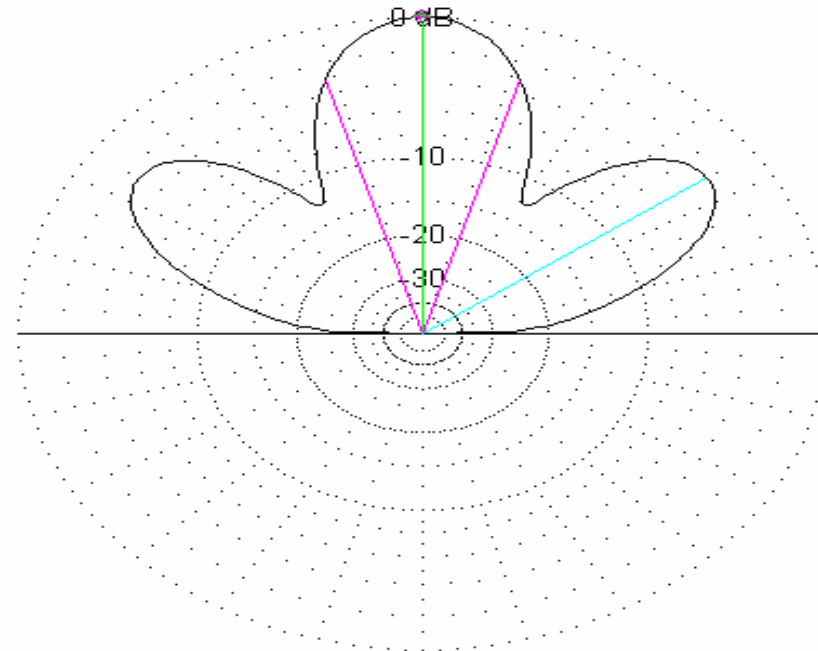

Elevation Plot
Azimuth Angle 0.0 deg.
Outer Ring 1.91 dBi

Slice Max Gain 1.91 dBi @ Elev Angle = 90.0 deg.
Beamwidth 33.2 deg.; -3dB @ 73.4, 106.6 deg.
Sidelobe Gain -0.7 dBi @ Elev Angle = 35.0 deg.
Front/Sidelobe 2.61 dB

14 MHz

Cursor Elev 90.0 deg.
Gain 1.91 dBi
0.0 dBmax

Current Distribution

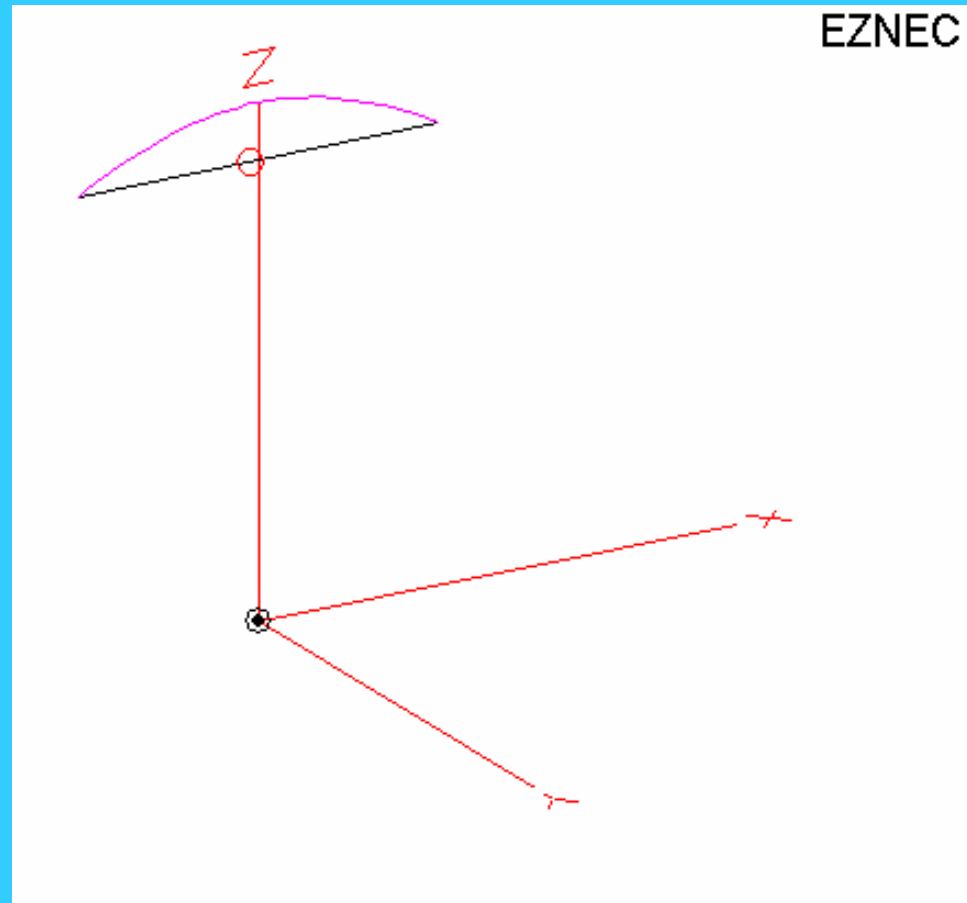

Multiband Dipole

- **Total length of one-half wavelength at lowest operating frequency**
- **Use current balun**
- **Must use antenna tuner – lower losses for tuner which has air inductor rather than toroid inductor**
- **Install with feedpoint as high as possible (except for NVIS operation)**

Feedlines

- **Coax**
 - Either 50 ohm or 75 ohm impedance
 - RG-58 has too high of losses; RG-8 and 8X is preferred
 - Attached to antenna using 1:1 current balun
 - For multiband use, use antenna tuner
- **Open line**
 - Generally 300 ohm or 450 ohm
 - Attach directly to antenna
 - Use a 4:1 balun at antenna tuner

Typical Open-Wire Feed Setup

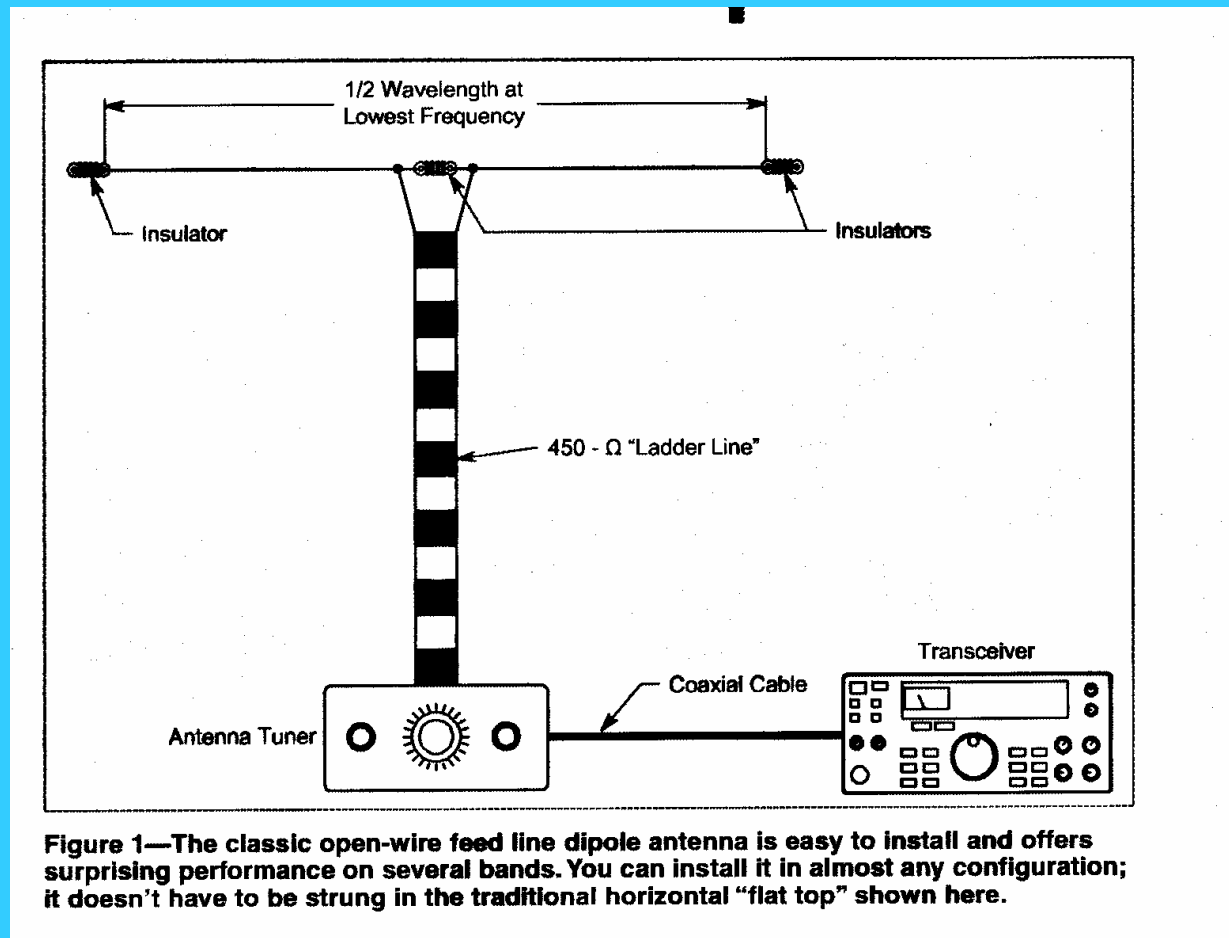

Figure 1—The classic open-wire feed line dipole antenna is easy to install and offers surprising performance on several bands. You can install it in almost any configuration; it doesn't have to be strung in the traditional horizontal "flat top" shown here.

Other Configurations for a Dipole Antenna

Inverted – Vee

Folded Dipole

Sloper Dipole

G5RV

Coaxial dipole

Two Band, Single Feed Dipole

Inverted L Dipole

Inverted-Vee Dipole Antenna

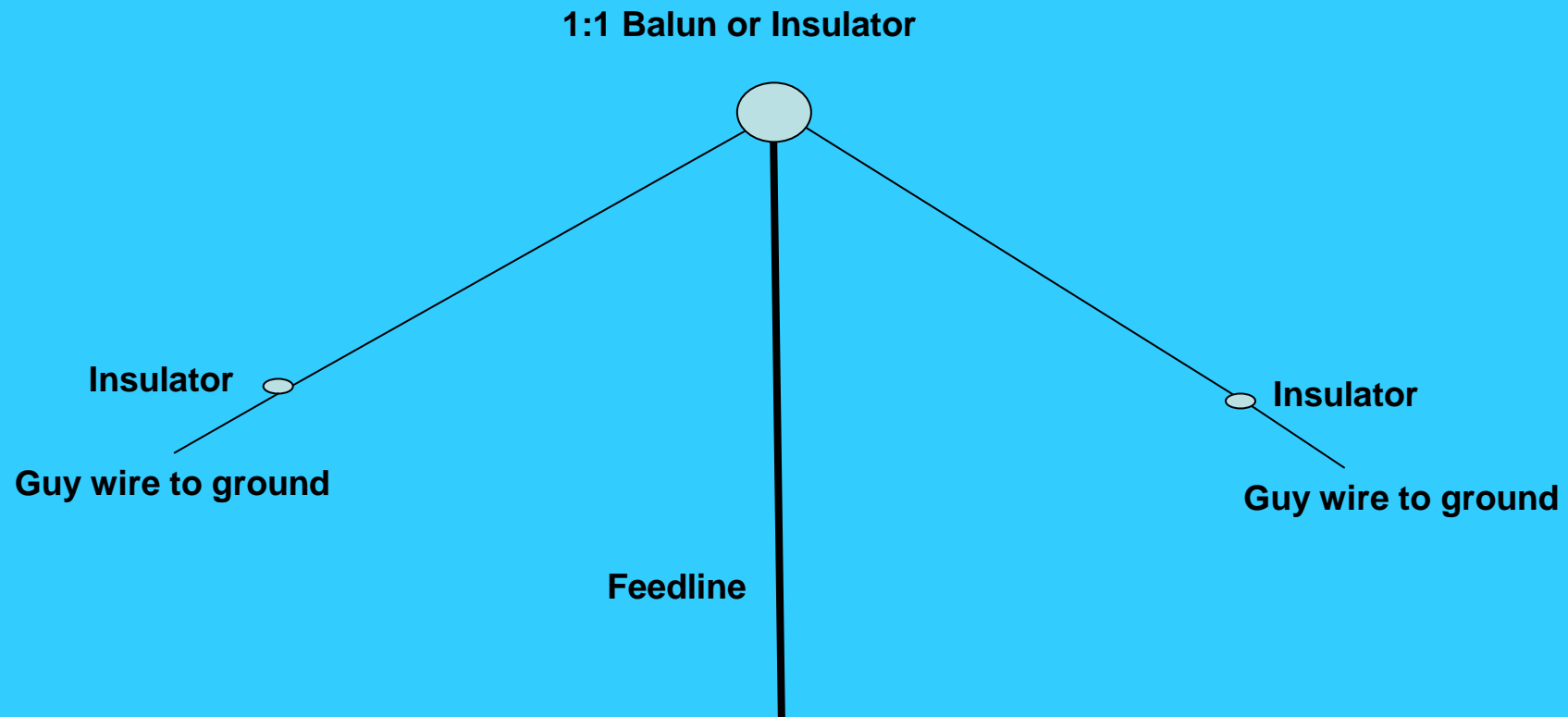

Inverted – Vee Dipole Antenna

- Apex up as high as possible**
- Keep angle between legs over 90°**
- Use insulators at far end of legs**
- Far end of legs should be at least 2 feet above the actual ground, higher is no problem**
- Impedance closer to 50 ohms**
- Lower take-off angle of radiation than horizontal dipole**

Inverted-Vee Dipole Antenna

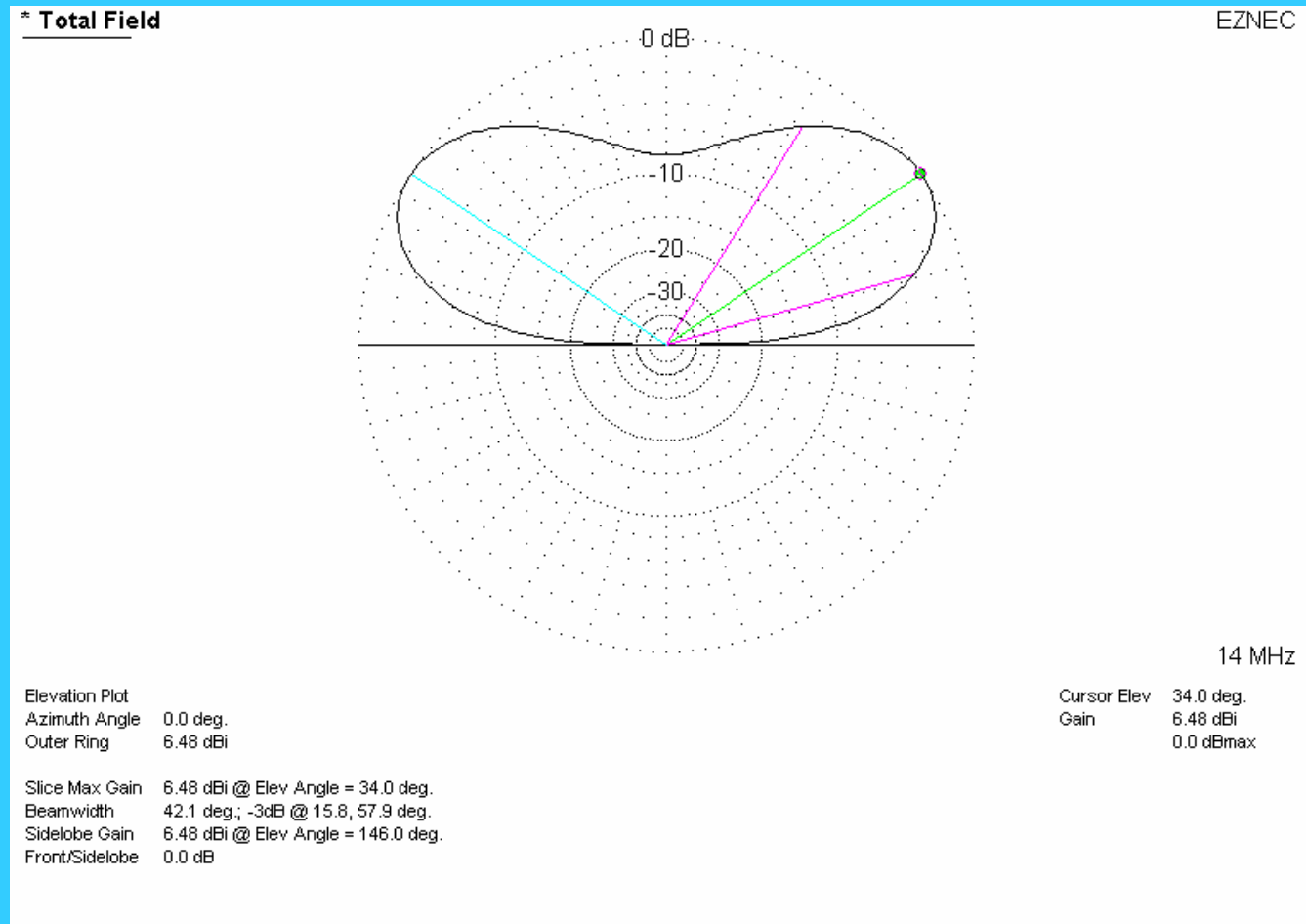

Inverted – Vee Folded Dipole

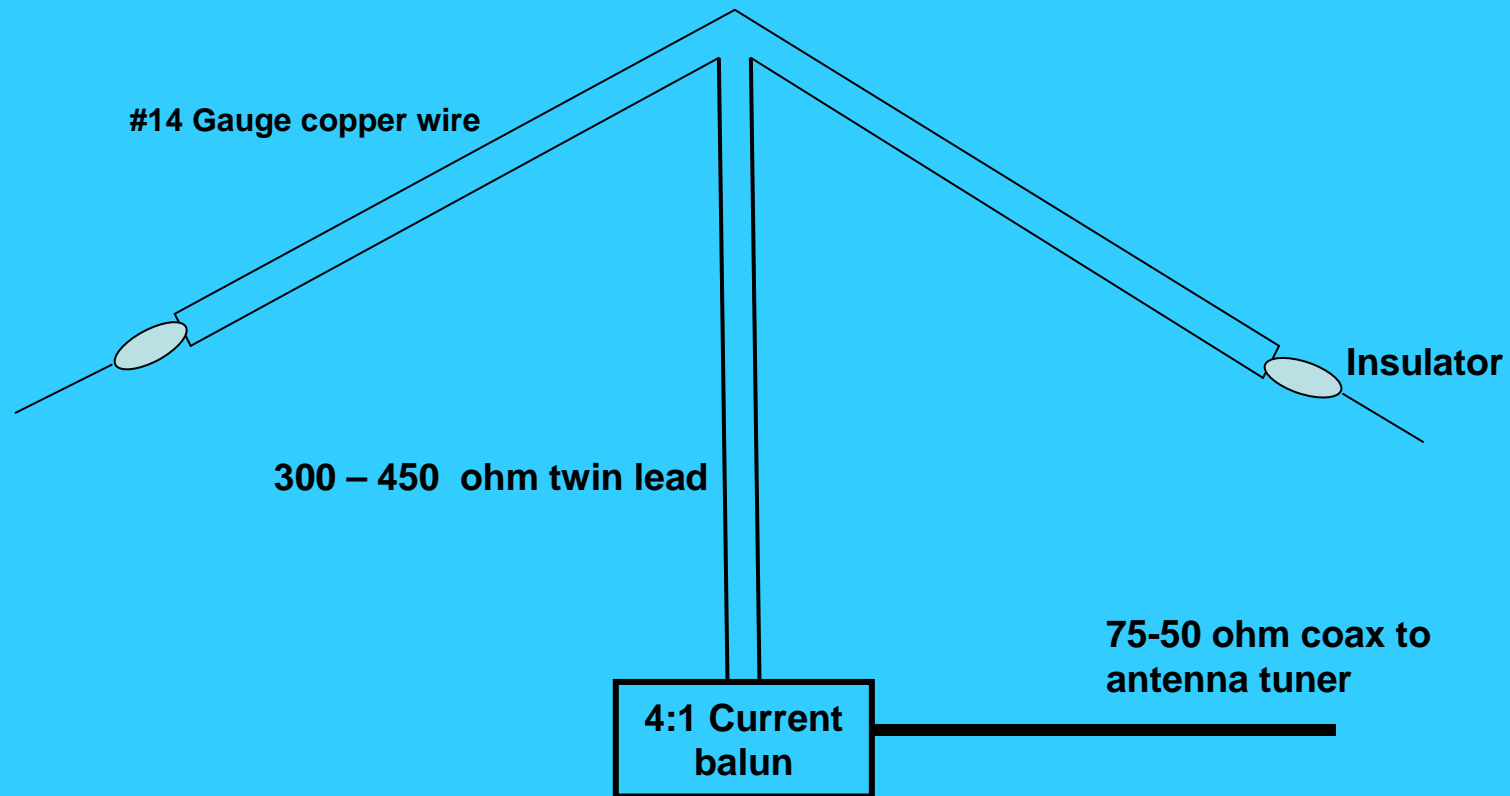

Folded Dipole

- **Somewhat greater 2:1 SWR bandwidth**
- **Feedpoint impedance approximately 300 ohms**
- **Ideal for open line feed**
- **Use 4:1 current balun and antenna tuner**
- **If you use coax, install balun at antenna feed point**
- **Spacing between folded legs not very important – 2-3 inches and greater**

Sloping Dipole

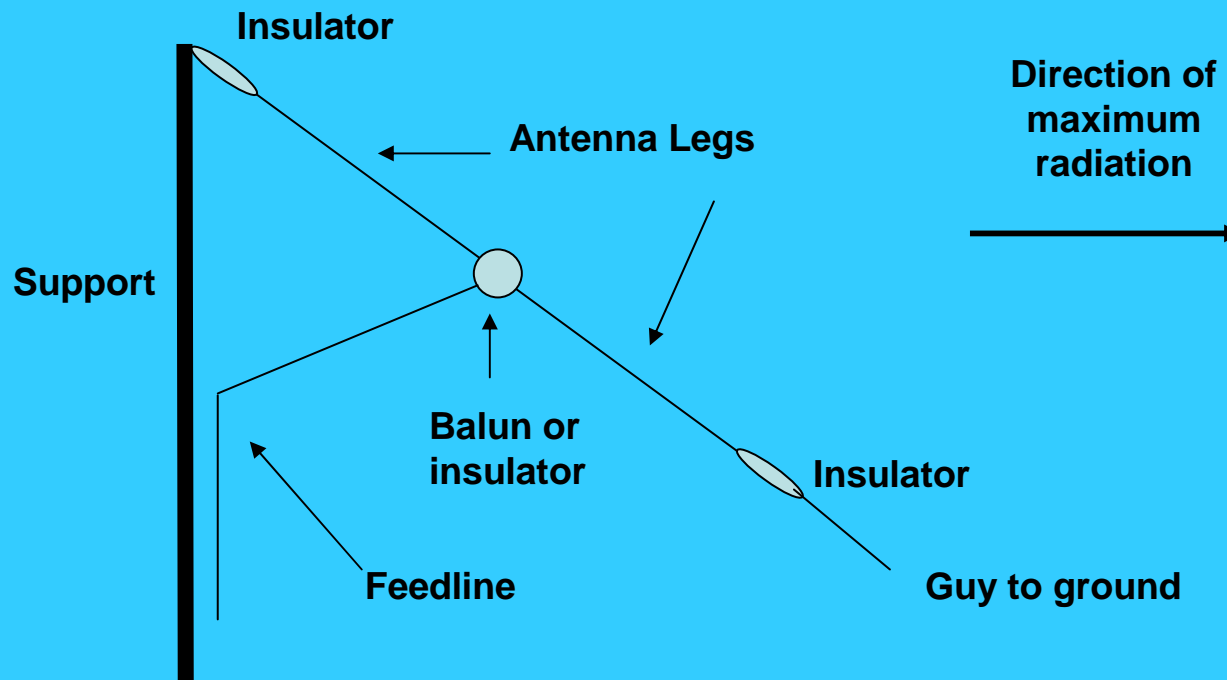

Sloping Dipole

- **More RF energy in direction of slope**
- **Feedline at 90° from antenna**
- **Feed point resistance – $\cong 74$ ohms**
- **High end as high as possible**
- **Use insulators an high and low end**

Sloping Dipole

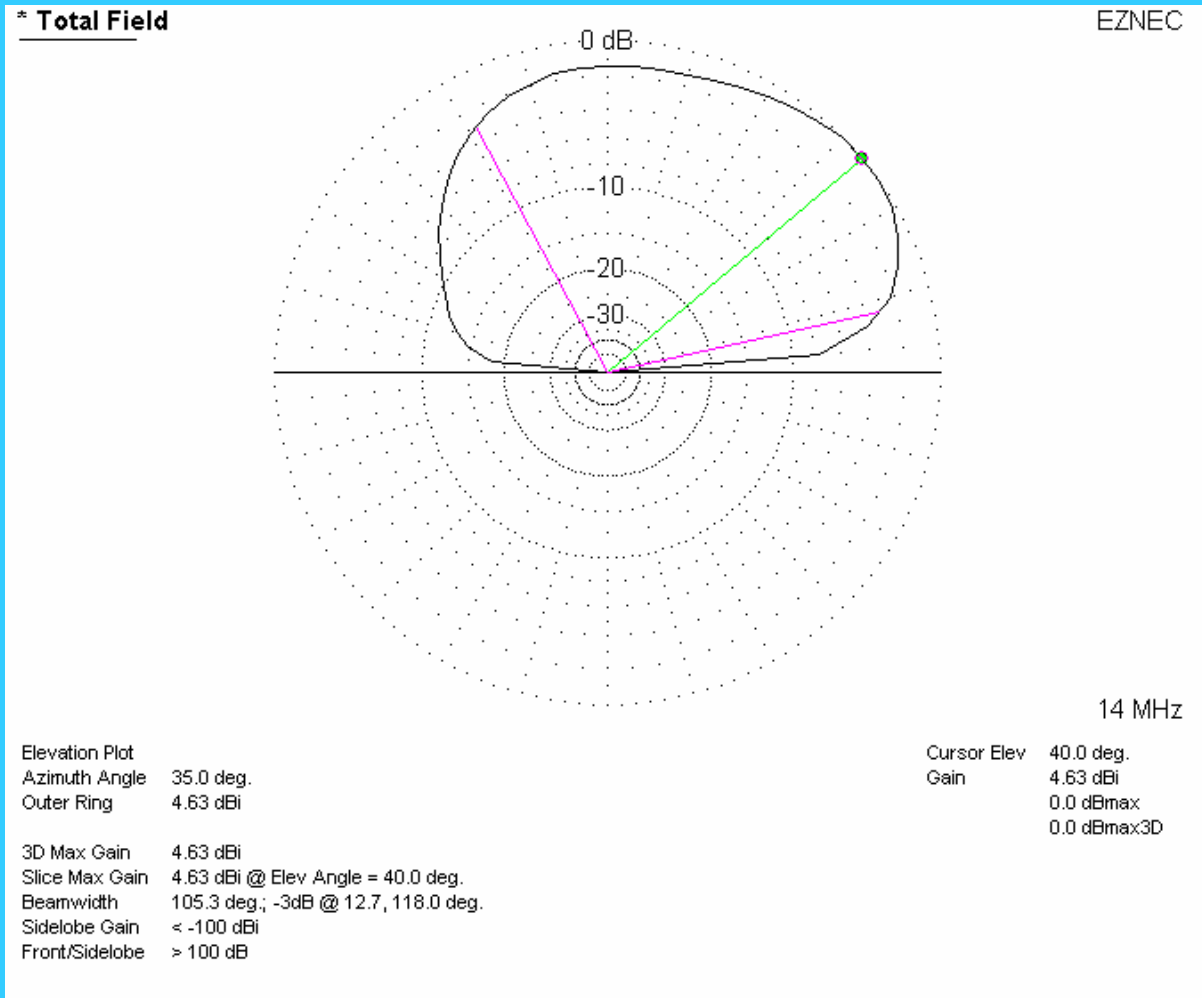

G5RV Dipole

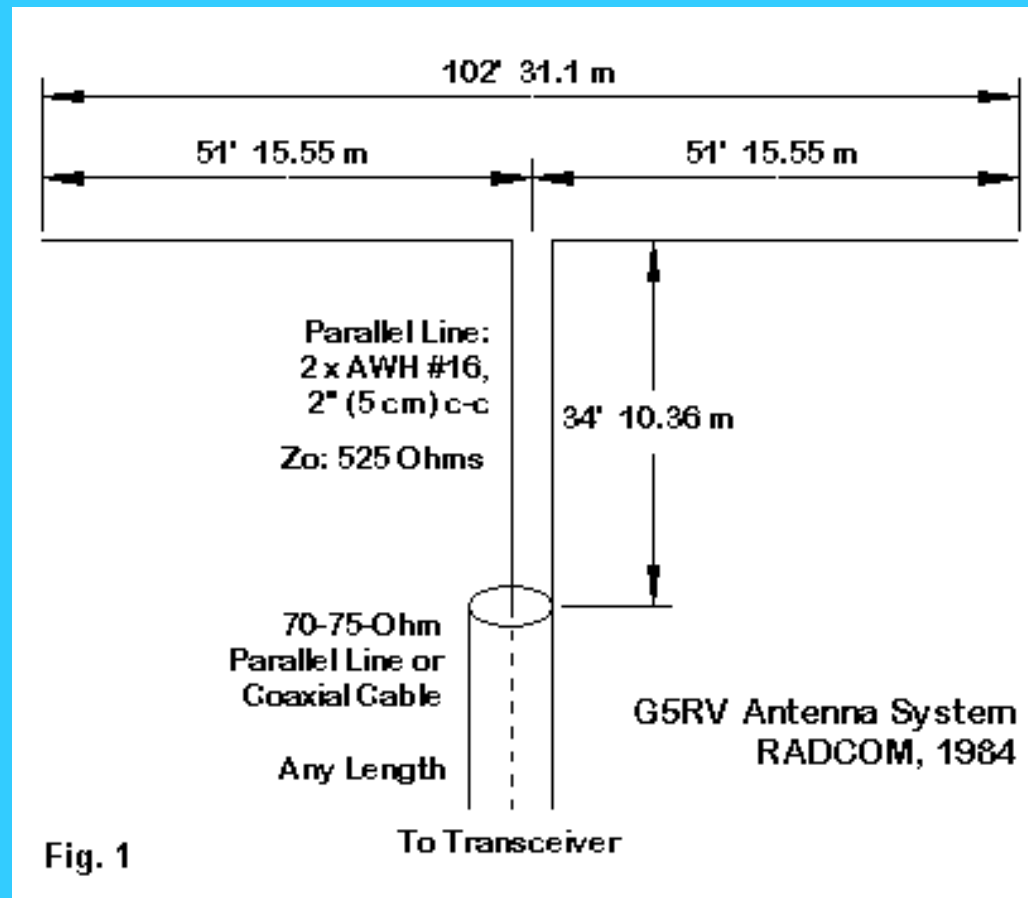

Source: <http://www.cebik.com/wire/g5rv.html>

G5RV Dipole

- **Multi-band dipole**
- **Use 1:1 current balun at end of twin lead feedline**
- **Coax to antenna tuner any length**
- **Great for inverted-vee installation**
- **Have twin lead run perpendicular to antenna**

Coaxial Dipole – Double Bazooka

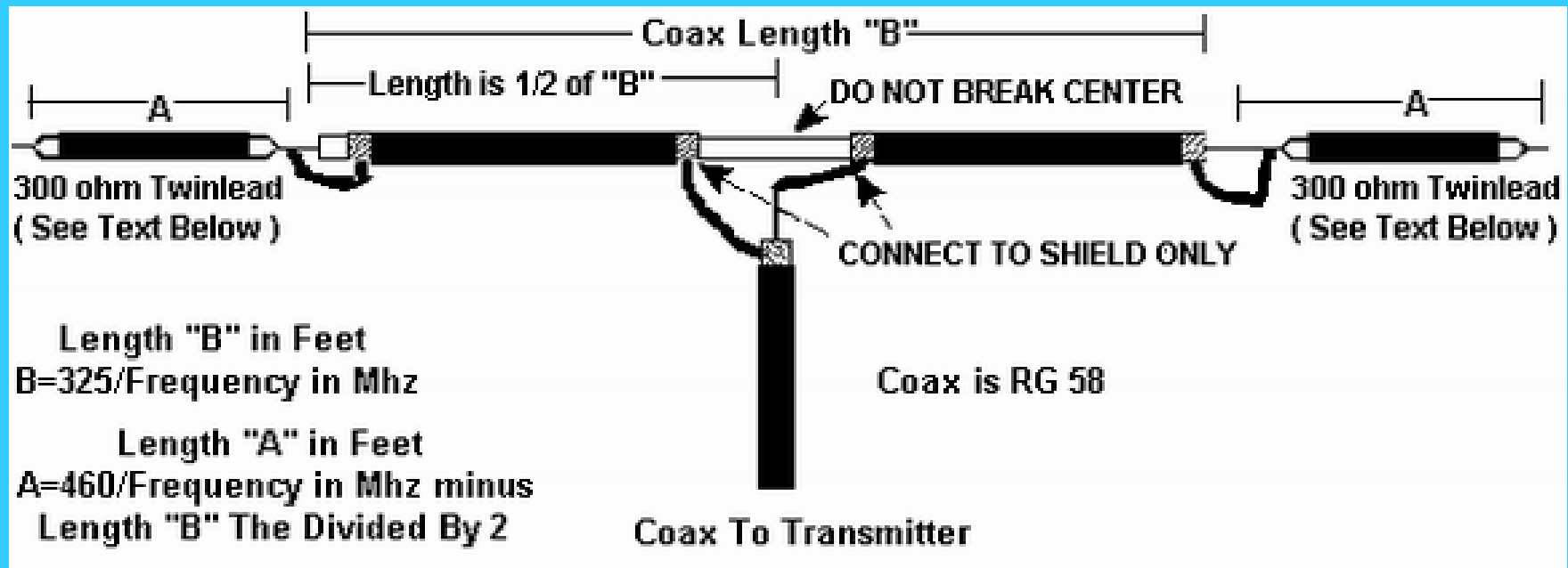

Source: <http://www.n4hlf.com/index.html?http://www.n4hlf.com/bazooka.htm>

Coaxial Dipole – Double Bazooka

- **Supposed to give more 2:1 SWR bandwidth, but only marginally**
- **Some technicians say the antenna performs better than a traditional dipole, but all mathematical analyses say “no”**
- **“Cross-over Double Bazooka” does give somewhat more 2:1 SWR bandwidth**

Two Band, Single Feed Dipole

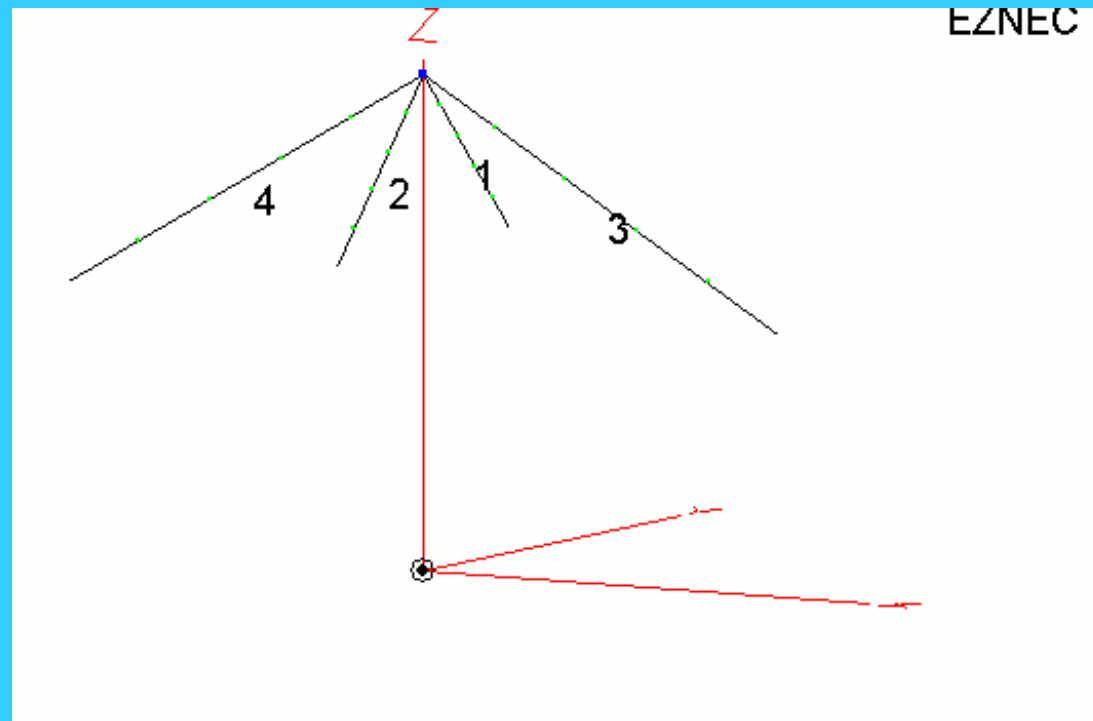

Two Band, Single Feed Dipole

- **Make a 40 meter dipole and feed with twin lead or balun and coax**
- **Make a 20 meter dipole and attach at same feed as 40 meter dipole**
- **40 meter operation has very high impedance for 20 meter dipole so all energy to 40 meter dipole**
- **20 meter operation has very high impedance for 40 meter dipole so all energy to 20 meter dipole**

Inverted L Dipole

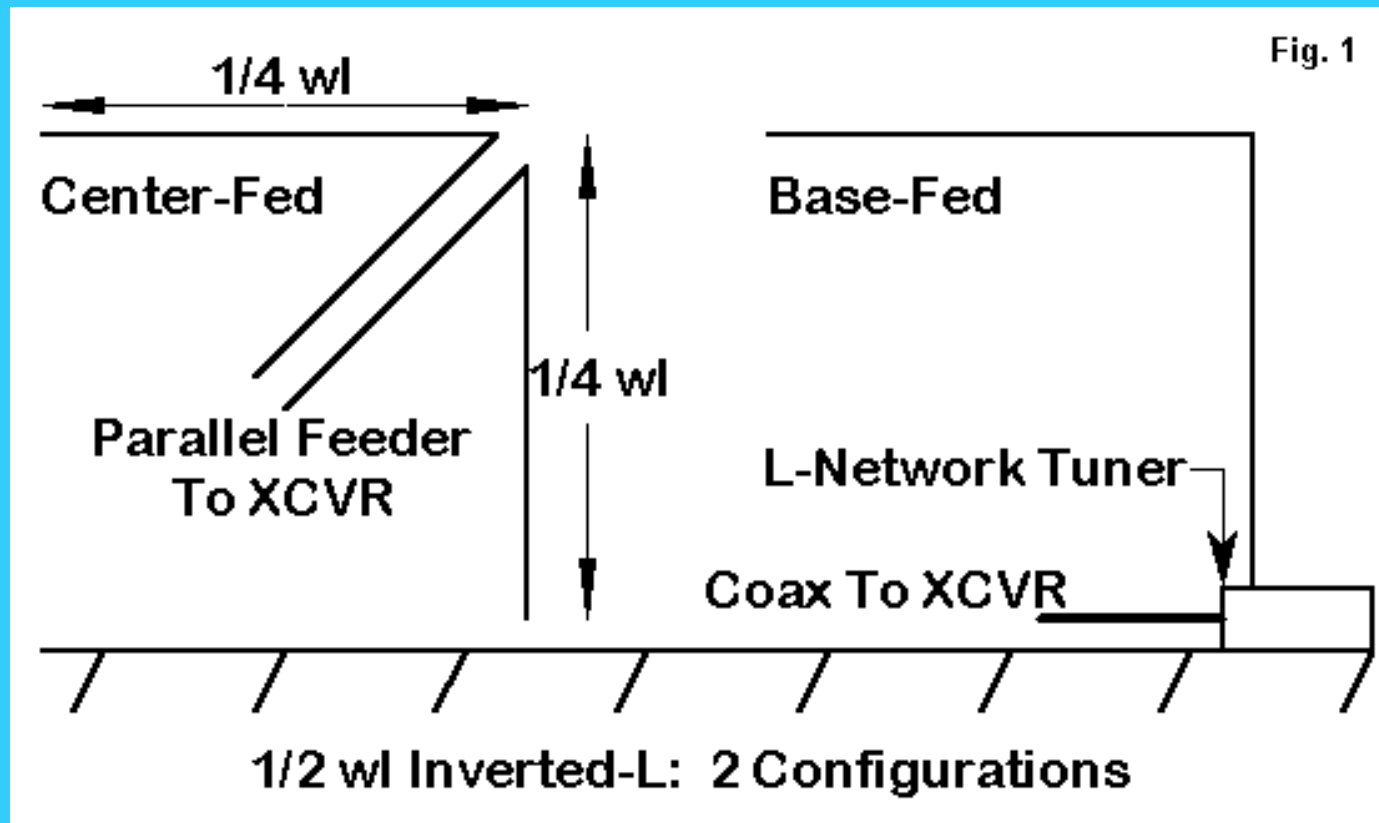

Source: <http://www.cebik.com/gup/gup25.html>

Inverted L Dipole

- **An antenna that is part vertical and part horizontal**
- **If fed in the center or at the base of the antenna, no radials or counterpoise are necessary**
- **Gives a good low take-off from the vertical portion and a high take-off angle from the horizontal portion – although $\frac{1}{2}$ power to each leg's radiation**
- **Feed point is about 65 ohms resistance for antenna at resonance**

Making and Adjusting A Simple Dipole

1. Calculate the total length using the formula: $468/\text{Freq. in mhz}$, or $468/7.1 = 65 \text{ ft. } 11''$.
2. Each leg is then $32 \text{ ft. } 11.5''$; start by cutting each leg to $34 \text{ ft. } 6''$.
3. Permanently attach each leg to the center insulator or balun .
4. Loop $6''$ of wire the through the far end insulator and twist around leg.
5. Attach feed line and elevate the dipole in place.

Making and Adjusting A Simple Dipole with SWR Meter

- 6. Measure dipole SWR at design frequency. SWR will be high. Dipole resonance is lower in frequency (dipole too long).**
- 7. Lower dipole and cut off 3" from each leg. Raise and repeat SWR measurement.**
- 8. Repeat 7. until dipole has an SWR of 1.5:1 or less. As the SWR approaches 1:1, cut off less from each leg per adjustment.**
- 9. When the dipole is adjusted, without affecting length, twist the wire passing through the end insulator around leg and solder.**
- 10. Re-elevate antenna and enjoy!**

Making and Adjusting A Simple Dipole with Antenna Analyzer

- 1. Calculate to total length using the formula: $468/\text{Freq. in mhz}$, or $468/7.1 = 65 \text{ ft. } 11''$.**
- 2. Each leg is then $32 \text{ ft. } 11.5''$; start by cutting each leg to $34 \text{ ft. } 6''$.**
- 3. Permanently attach each leg to the center insulator or balun .**
- 4. Loop the far end onto the insulator.**
- 5. Attach feed line and elevate the dipole in place.**

Making and Adjusting A Simple Dipole with Antenna Analyzer

6. Attach analyzer to feedline and tune for resonance (where reactance is zero).
7. Multiple leg length by two and by frequency on analyzer. (should be 425-490)
8. Divide the this number by your design frequency. This is the total antenna length. Divide by 2 for each leg length.
9. Lower antenna and cut leg to calculated length. Re-elevate and confirm.
10. If SWR is less than 1.5:1, solder leg ends around insulator, re-elevate and enjoy!

Final Thoughts About Dipoles

- They are forgiving and have many variations
- They give excellent performance for their simplicity, are easy to build, and fun for experimentation.
- Two horizontal parallel dipoles about 0.15 to 0.2 wavelengths apart to form a two-element yagi.
- Inverted-vee's can also be constructed to be 0.15 to 0.2 wavelengths apart to form a two-element "yagi."

References

Cebik, L. B., W4RNL, "The G5RV Antenna System Re-Visited, Parts 1, 2, and 3," <http://www.cebik.com/wire/g5rv.html>, © L. B. Cebik, 2003.

Cebik, L.B., W4RNL, "A 1/2 Wavelength Inverted-L Multi-Band Antenna Data Compendium," <http://www.cebik.com/gup/gup25.html>, © L. B. Cebik, 2013.

Devoldere, John, ON4UN, ***ON4UN's Low Band DXing***, The ARRL, Inc., Newington, CT, 1999-2002

Feidler, David M. and Edward J Farmer, ***Near Vertical Incidence Skywave Communication: Theory, Techniques and Validation***, World Radio Books, Sacramento, CA, 1996

Ford, Steve, WB8IMY, "The Classic Multiband Dipole Antenna," ***QST***, March 2004, pg. 65

Hall, Jerry, K1TD, "The Search for a Simple Broadband 80-Meter Dipole," ***QST***, April 1983, pp. 22-27

Healey, James, NJ2L, "Antenna Here is a Dipole," ***QST***, June 1991, pp. 23-26

More References

Healey, James, NJ2L, "Feeding Dipole Antennas," *QST*, July 1991, pp.22-24

Hutchinson, Chuck, K8CH, editor, *More Wire Antenna Classics, Volume 2*, The ARRL, Newington, CT, 1999-2002

Maxwell, Walter, W2DU, *Reflections II: Transmission Lines and Antennas*, World Radio Books, Sacramento, CA, 2001

Michaels, Charles, W7XC, "Dipoles Above Real Earth," Technical Correspondence, *QST*. November 1992, pp. 67-69

Reed, Dana, KD1CW, editor, *ARRL's Wire Antenna Classics*, The ARRL, Inc., Newington, CT, 1999-2005

Straw, Dean, N6BV, editor, *The ARRL Antenna Handbook, 20th edition*, The ARRL, Inc., Newington, CT, 2003

Witt, Frank, AI1H, "Broadband Dipoles – Some New Insights," *QST*, October 1986, pp. 27-37

Dipole-Dipole is a pole dance performance. The powerful act is sometimes done solo, sometimes in a duo, but always in style. See more of Dipole-Dipole on Facebook. Log In. or. Create New Account. See more of Dipole-Dipole on Facebook. Log In. Forgotten account?